

► Hybrid stepper motors

6600-15

- Step angle..... 1.8°
- Size 57.2 mm
- Weight 370 g
- Holding torque ... 540/385 mNm

The hybrid stepper motor comes into its own where torque at low speed, positioning, and accuracy are determining factors..

► Technical data

	Part N°	Phase resistance [Ω]	Phase inductance [mH]	Phase current [A]	Holding torque [mNm]	Nominal power [W]		
Bipolar	6600-15-2-1.6	1.6	3.5	1.5	540	7.2	Steps/rev.	200
Unipolar	6600-15-4-1.6	1.6	1.7	1.5	385	7.2	Step accuracy	± 5%
	6600-15-4-13.5	13.5	13.9	0.52	385	7.2	Rotor inertia	131 gcm²
							Insulation class	B 130 °C
							Protection	DIN 40050 IP 30
							Test voltage	500 VAC
							Detent torque	26 mNm

► Dimensions

Drawing not to scale. All dimensions in mm.

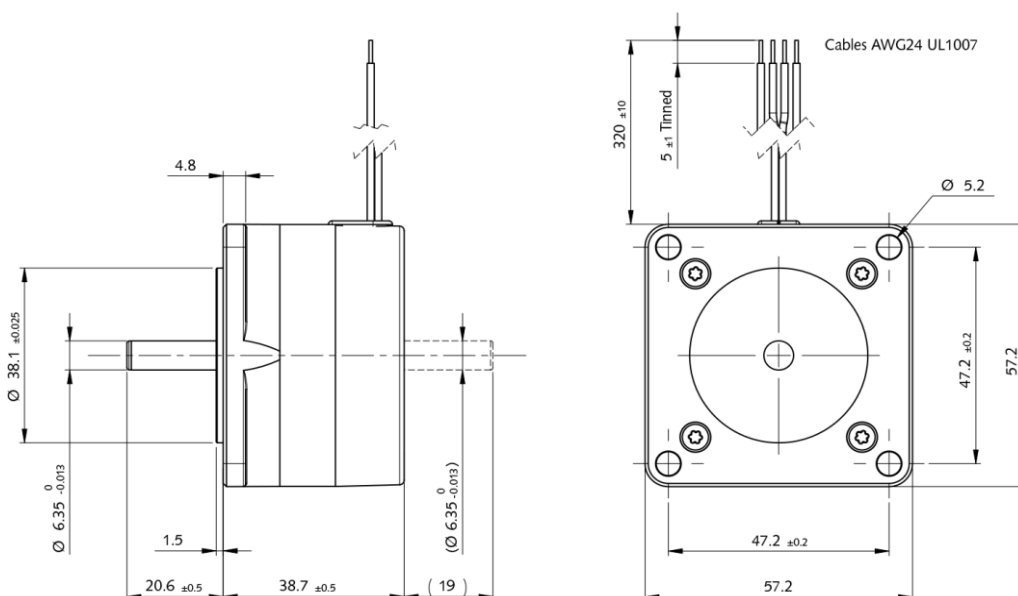

► Dynamic characteristics

• 6600-15-2-1.6

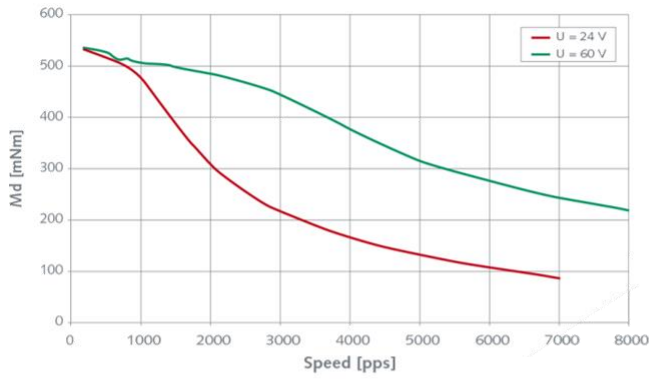

[pps] = pulses per second

• 6600-15-4-1.6

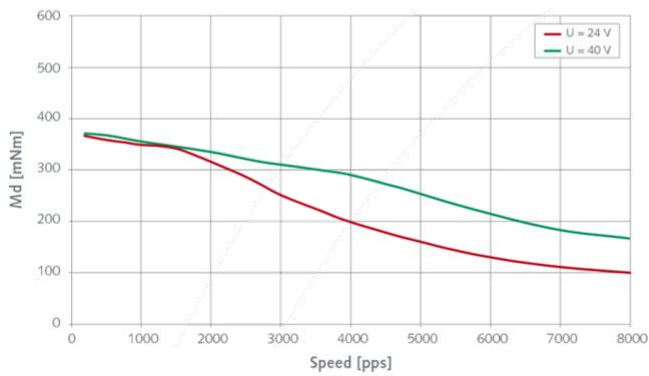

• 6600-15-4-13.5

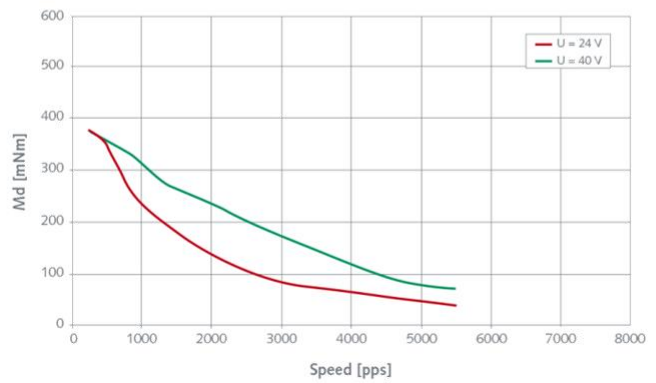

► Static characteristics

• 6600-15-2 Series

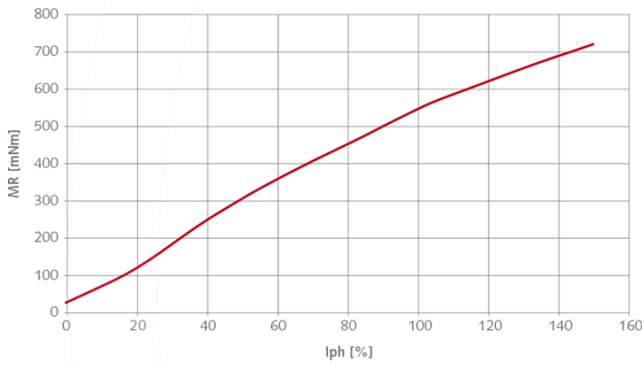

• 6600-15-4 Series

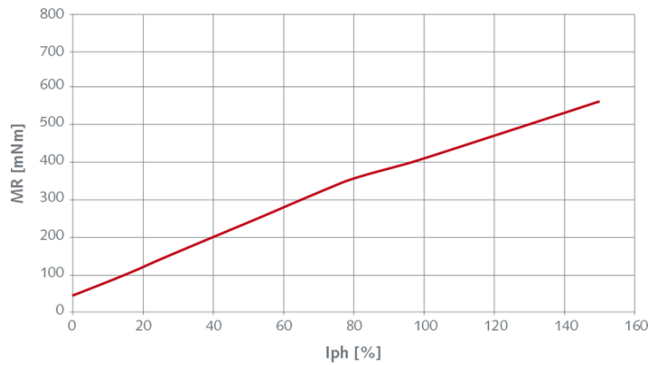

► Electrical Interface

• Bipolar

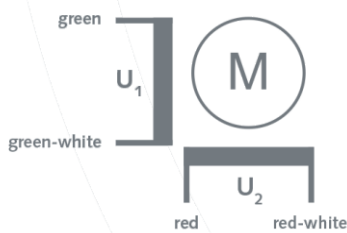

• Unipolar

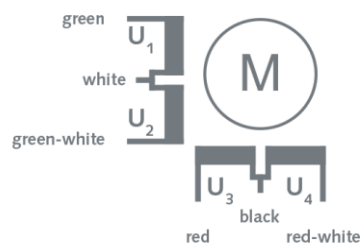

Special requirements upon customer specifications. Right to change reserved.

<2.0>

SONCEBOZ SA

2605 Sonceboz – Switzerland

Tel. +41(0) 32 488 11 11

Fax +41(0) 32 488 11 00

info@sonceboz.com - www.sonceboz.com

