



## ► Slimline stepper motors

### 6405 R47X

- Nominal Torque .... 1.7 mNm
- Output shaft .....  $\text{Ø}1.5^{-0.003} /_{-0.013}$  mm held by a dome
- Designed to withstand high vibration levels

The robust design of the Heavy Duty 6405R47X stepper motors optimises the motion performances, particularly with high inertia pointers and withstands outstanding vibration levels. Compatible with SMD contacts allowing solderless electrical connection.

### ► Technical data

Part N°	Position on PCB	Shaft length	Shaft Ø	Distance between rivets
6405R472	Rear Mount	13.3 mm	$\text{Ø}1.5^{-0.003} /_{-0.013}$ mm	21 mm
6405R473	Rear Mount	21.7 mm	$\text{Ø}1.5^{-0.003} /_{-0.013}$ mm	21 mm
6405R475	Rear Mount	21.7 mm	$\text{Ø}1.5^{-0.003} /_{-0.013}$ mm	25 mm

### ► Dynamic characteristics

Dynamic torque at 22° C, coil voltage 5 V, for motors driven in 1/6 micro-steps

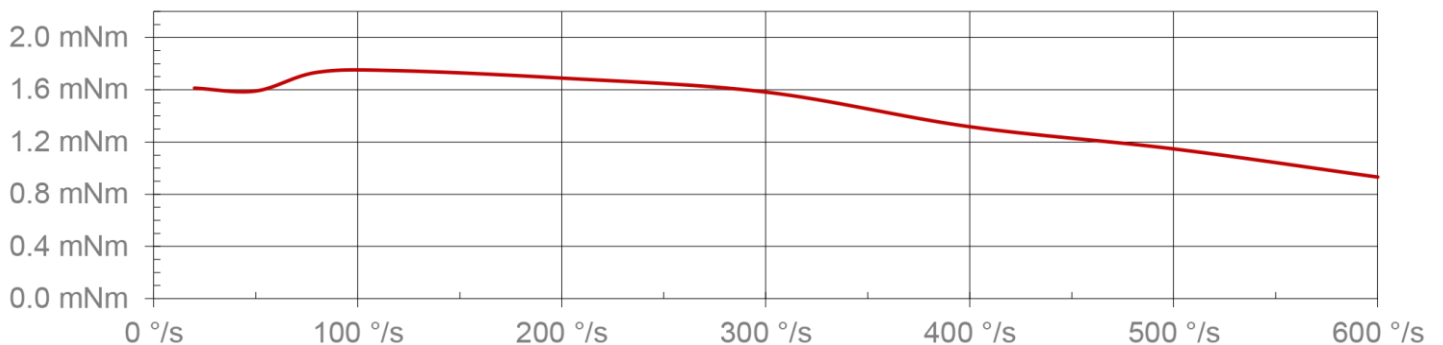

► Dimensions

Drawing not to scale. All dimensions in mm.

• 6405R472

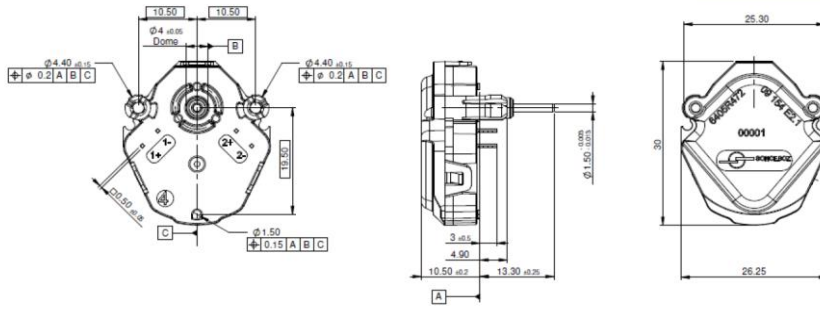

Reference for pins measurement

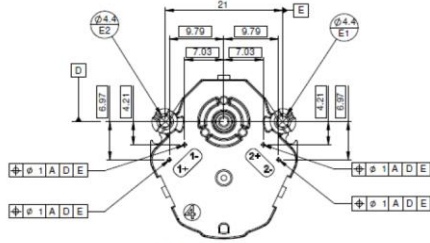

A: surface bearing  
D: line between point E1 and point E2  
E: middle point between point E1 and point E2

Recommended circuit board hole pattern

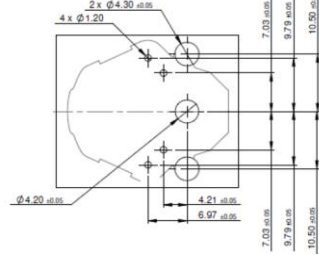

• 6405R473

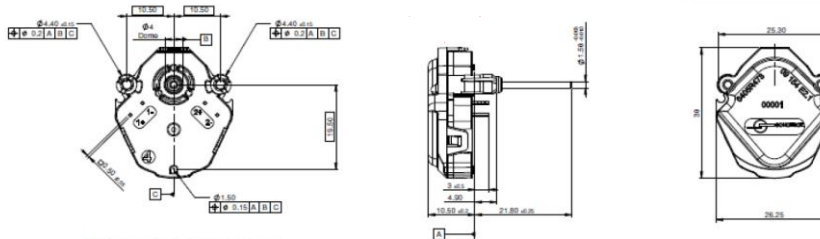

Reference for pins measurement

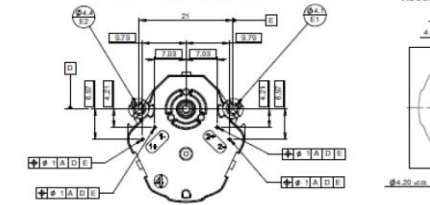

A: surface bearing  
D: line between point E1 and point E2  
E: middle point between point E1 and point E2

Recommended circuit board hole pattern

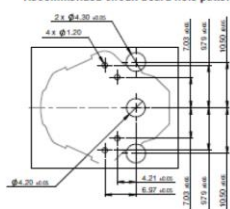

• 6405R475

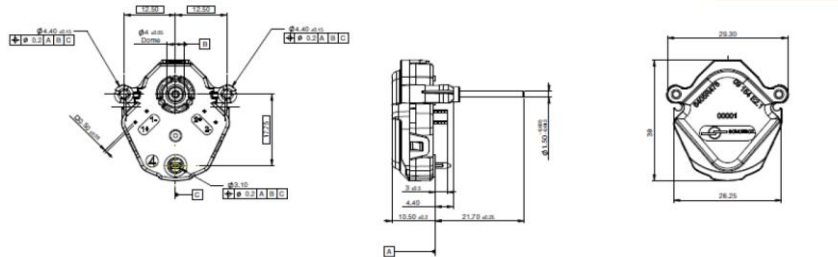

Reference for pins measurement

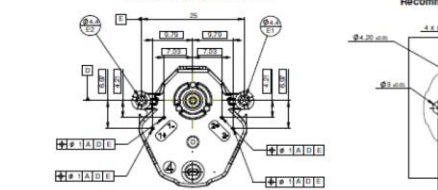

A: surface bearing  
D: line between point E1 and point E2  
E: middle point between point E1 and point E2

Recommended circuit board hole pattern

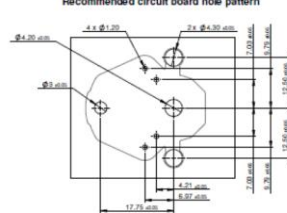

Special requirements upon customer specifications. Right to change reserved.

<2.0>

SONCEBOZ SA

2605 Sonceboz – Switzerland

Tel. +41(0) 32 488 11 11

Fax +41(0) 32 488 11 00

info@sonceboz.com - www.sonceboz.com



## ► Electrical / Mechanical Characteristics

Parameter	Min	Typical	Max	Unit
Rotor step angle	–	18	–	degree
Gear ratio	–	1:36	–	–
Pole pairs rotor	–	5	–	–
Step size degree in full step mode	–	0.5	–	degree
Step size degree with 6 micro steps	–	0.083	–	degree
Operating angle	300	310	–	degree
Operating temperature	-40	–	105	C
Storage temperature	-50	–	105	C
Soldering temperature (max 5 sec)	–	–	290	C
Operating voltage	4.5	–	7.5	V
Operating current	–	20	35	mA
Coil resistance	214	227	240	Ω
Coil Inductance	45	55	65	mH
Dynamic torque @ 200 degree / sec	1.3	1.7	–	mNm
Static torque	0.5	0.8	–	mNm
Holding torque (with current, 5 V)	–	3.6	–	mNm
Noise level @ 200 degree / sec @ 5 cm from the reference face, pre-test	–	26	35	dB (A)
Maximum speed	800	–	–	degree/s
Equivalent motor inertia at output	–	4.9 E-06	–	kg m <sup>2</sup>
Permissible forces on output shaft				
Axial force (with retention of the housing)	–	–	120	N N
Radial force at 8 mm from front face of motor	–	–	24	

## ► Variables

**Ambient temperature:** Ta = 22°C

**Voltage at the coils:** U = 5V±0.1V

Special requirements upon customer specifications. Right to change reserved.

<2.0>

**SONCEBOZ SA**

2605 Sonceboz – Switzerland

Tel. +41(0) 32 488 11 11

Fax +41(0) 32 488 11 00

info@sonceboz.com - www.sonceboz.com

